

17 o. Abb. / no ill.
Isolatorsatz
Insulator set

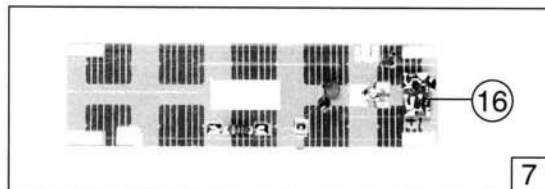

Pos. Nc.	Text	Art.-Nr.	Preisgruppe
1	Stromabnehmer Pantograph	85287	38
2	Schraube M 1,6 x 5 Screw M 1,6 x 5	85692	2
3	Schraube M 2 x 5 Screw M 2 x 5	85715	2
4	Schraube M 1,6 x 6 Screw M 1,6 x 6	85811	2
5	Isolierhülse Insulating tube	86111	2
6	Feder Spring	86215	2
7	Platine komplett Printed circuit assembly	87799	43
8	Umschaltkontakt Switch contact	89709	2
9	Schaltbolzen Switch pin	89721	9
10	Kontaktstreifen Contact strip	89776	4
11	Schaltkontakt für 43005 Switch contact for 43005	89961	4
12	Dachleitungssatz Roof conducting wire set	93430	12
13	Leuchtstab Light transmissions bar	93434	4
14	Platinenhalter Printed circuit holder	93436	2
15	Sofitte Tubular-lamp	93517	10
16	Brückenstecker Connector	100644	7
17	Isolatorsatz Insulator set	101764	34
18	Dach komplett für 43005 Roof assembly for 43005	101765	52
19	Gehäuse komplett für 43005 Betr. Nr. 421 179-3 Body assembly for 43005 Betr. No. 421 179-3	101766	60
20	Fenstersatz für 43005 Glazing set for 43005	101767	25
21	Dachleitung lackiert für 43005 Roof wire for 43005	101768	3
22	Stromabnehmerisolator Pantograph insulator	101769	2
23	Inneneinrichtungssatz für 43005 Interior set for 43005	101816	12
24	Oberleitungsverbinder für 43006 Overhead supply connector for 43006	89778	4
25	Dach komplett für 43006 Roof assembly for 43006	101833	62
26	Gehäuse komplett für 43006 Betr. Nr. 421 171-0 Body assembly for 43006 Betr. No. 421 171-0	101834	60
27	Fenstersatz Motorwagen, Steuerwagen für 43006 Glazing set for 43006	101835	25
28	Inneneinrichtungssatz für 43006 Interior set for 43006	101836	12
29	Dachleitung lackiert für 43006 Roof wire for 43006	101837	3

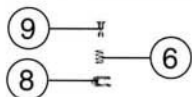
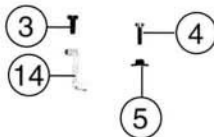
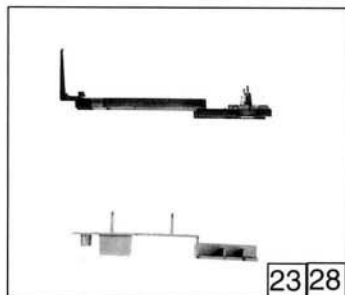
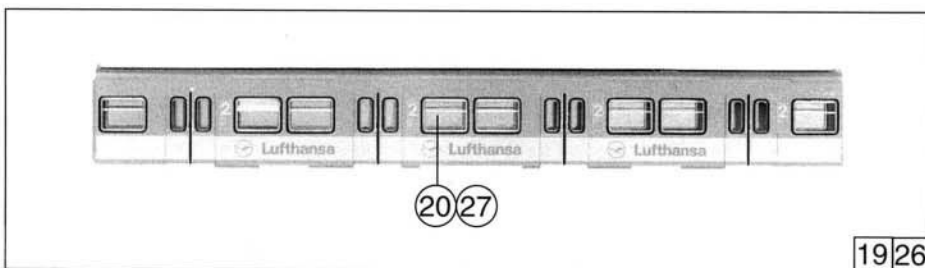
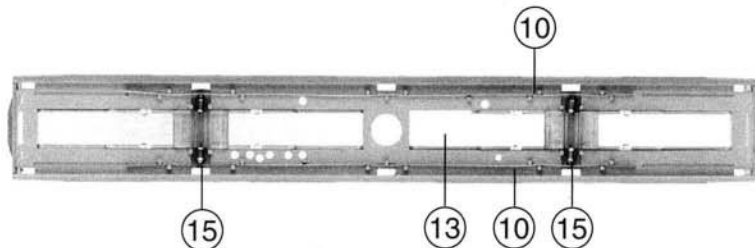
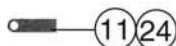
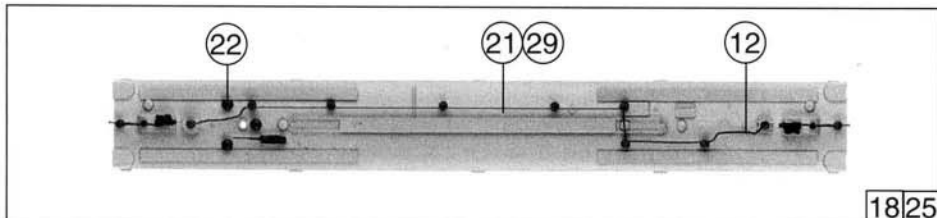
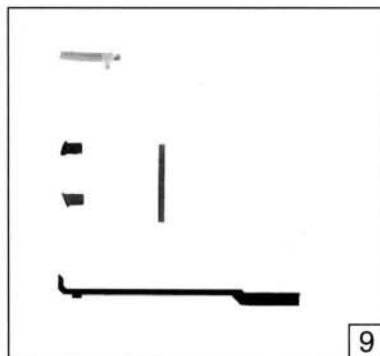
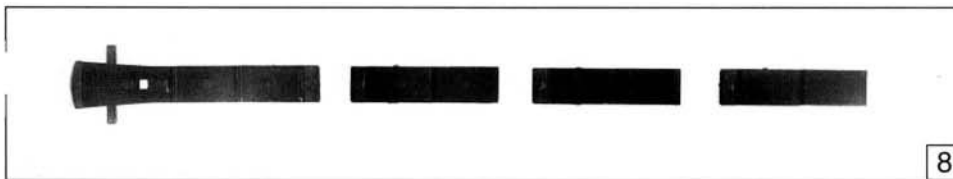
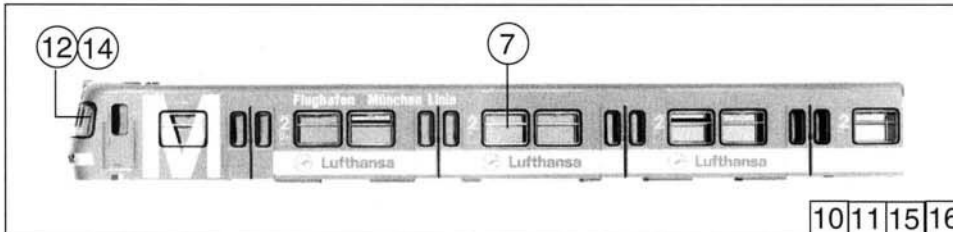
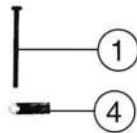
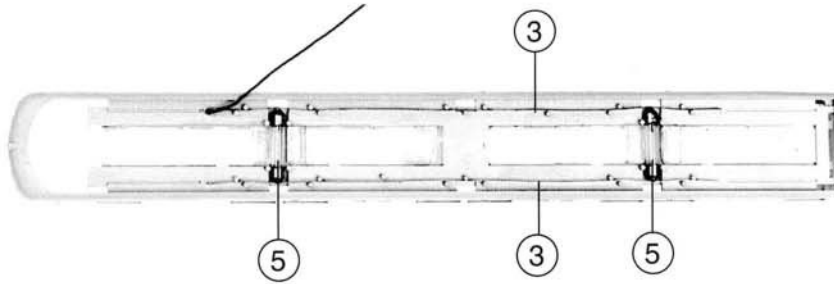
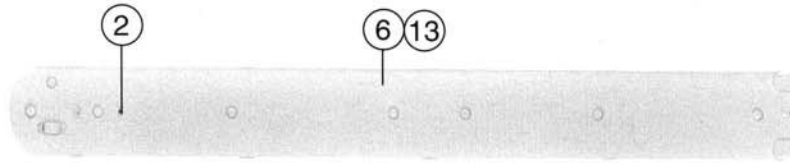

Pos. Nr.	Text	Art.-Nr.	Preisgruppe
1	Schraube M 2 x 25 <i>Screw M 2 x 25</i>	85759	2
2	Lokpfeife <i>Loco whistle</i>	88002	6
3	Kontaktstreifen <i>Contact strip</i>	89776	4
4	Lötfane <i>Contact</i>	89962	2
5	Sofitte <i>Tubular lamp</i>	93517	10
6	Dach für 43005 <i>Roof for 43005</i>	101778	25
7	Fenstersatz <i>Glazing set</i>	101779	25
8	Lichtleitstäbesatz 1 <i>Light transmissions bar set 1</i>	101780	16
9	Lichtleitstäbesatz 2 <i>Light transmissions bar set 2</i>	101781	16
10	Gehäuse komplett für 43005 St.w.1 <i>Body assembly 1 for 43005</i> Betr. Nr. 420 179-4	101782	60
11	Gehäuse komplett für 43005 St.w. 2 <i>Body assembly 2 for 43005</i> Betr. Nr. 420 679-3	101783	60
12	Stirfenster für 43005, St.w. 1; 2; <i>Front glazing for 1; 2; 43005</i>	101784	10
13	Dach für 43006 <i>Roof wire for 43006</i>	101839	25
14	Stirfenstersatz für 43006 <i>Glazing set for 43006</i>	101840	25
15	Gehäuse 1 komplett für 43006 <i>Body 1 assembly for 43006</i> Betr. Nr. 420 171-1	101843	60
16	Gehäuse 2 komplett für 43006 <i>Body 2 assembly for 43006</i> Betr. Nr. 420 671-0	101844	60

Pos. Nr.	Text	Art.-Nr.	Preisgruppe
1	Schraube M 2 x 5 <i>Screw M 2 x 5</i>	85715	2
2	Schraube M 2,2 x 9,5 <i>Screw M 2,2 x 9,5</i>	85808	2
3	Platine komplett <i>Printed circuit assembly</i>	87692	22
4	Scharfenbergkupplung <i>Scharfenberg coupler</i>	89214	3
5	Gewicht <i>Weight</i>	93416	14
6	Glühlampe <i>Lamp</i>	93518	12
7	Glühlampe rot <i>Lamp red</i>	93522	14
8	Kupplung <i>Coupling</i>	101785	3
9	Radsatz <i>Wheelset</i>	101786	16
10	Abdeckplatte vorne <i>Cover plate front</i>	101787	8
11	Abdeckplatte hinten <i>Cover plate rear</i>	101788	6
12	Abdeckplatte <i>Cover plate</i>	101789	2
13	Drehgestellblende 1 <i>Bogie frame 1</i>	101790	23
14	Drehgestellblende 2 <i>Bogie frame 2</i>	101791	23
15	Drehgestell 1 komplett <i>Bogie 1 assembly</i>	101792	40
16	Drehgestell 2 komplett <i>Bogie 2 assembly</i>	101793	40
17	Bodenplatte 1 für 43005 <i>Main frame 1 for 43005</i>	101794	30
18	Inneneinrichtungssatz St.w. <i>Interior set</i>	101815	30
19	Drehschemel mit Zapfen <i>Balance holder with pin</i>	101846	4
20	Drehschemel ohne Zapfen <i>Balance holder without pin</i>	101847	4
21	Bodenplatte 1 für 43006 <i>Main frame 1 for 43006</i>	101848	30
22	Bodenplatte 2 für 43006 <i>Main frame 2 for 43006</i>	101849	30
23	Bodenplatte 2 für 43005 <i>Main frame 2 for 43005</i>	101850	30

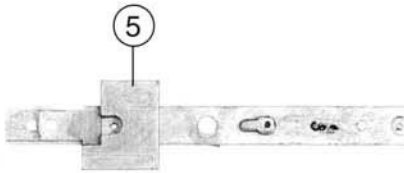
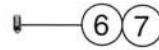
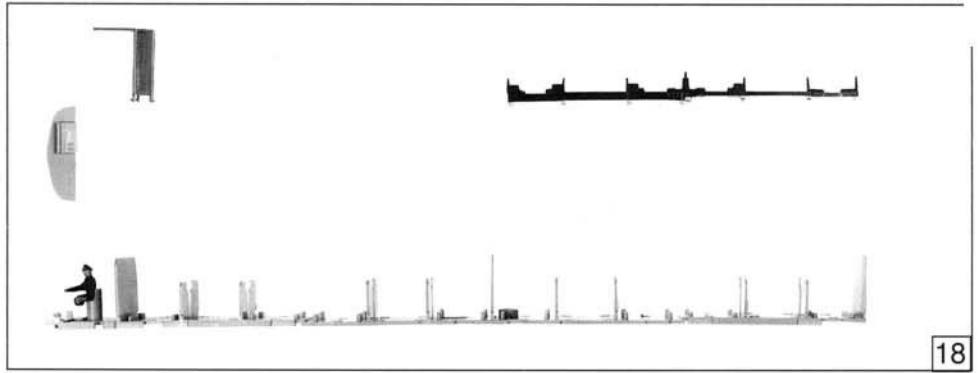

4 o. Abb. / no ill.
Scharfenbergkupplung
Scharfenberg coupler

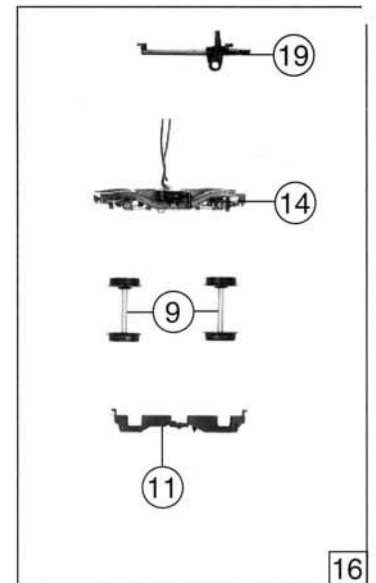
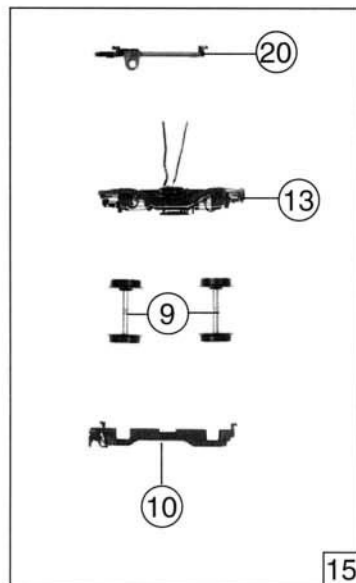
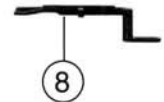
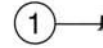
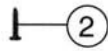

Pos. Nr.	Text	Art.-Nr.	Preisgruppe
1	Motor mit Schwungscheibe <i>Motor with flywheel</i>	85051	57
2	Haltring <i>Traction tyre</i>	85602	17
3	Schraube M 2 x 5 <i>Screw M 2 x 5</i>	85715	2
4	Zahnrad z=12; m 0,4 <i>Gear T=12; m 0,4</i>	86430	2
5	Zahnrad z=19; m 0,4 <i>Gear T=19; m 0,4</i>	86431	2
6	Zahnrad z=24; m 0,4 <i>Gear T=24; m 0,4</i>	86432	2
7	Zahnrad z=19; m 0,4 <i>Gear T=19; m 0,4</i>	86433	2
8	Schnecke <i>Worm</i>	86712	4
9	Kardanwelle <i>Cardan shaft</i>	87056	3
10	Kardanschale kurz <i>Cardan bearing short</i>	87057	2
11	Kardanschale lang <i>Cardan bearing short</i>	87076	2
12	Radkontakt <i>Wheel contact</i>	89858	3
13	Motorhalter <i>Motor holder</i>	93438	28
14	Getriebeklammer <i>Gear clamp</i>	93442	2
15	Getriebekasten links <i>Gear left</i>	93443	10
16	Getriebedeckel rechts <i>Gear cover right</i>	93444	10
17	Schneckensatz <i>Worm set</i>	101770	24
18	Kupplungsführung <i>Coupling</i>	101771	3
19	Drehgestellblende <i>Bogie frame</i>	101772	12
20	Getriebeabdeckung <i>Gear cover</i>	101773	5
21	Bodenplatte Motorwagen für 43005 <i>Main frame for 43005</i>	101774	30
22	Drehgestell komplett <i>Bogie assembly</i>	101775	51
23	Radsatz mit Haltring <i>Wheelset with traction tyre</i>	101776	20
24	Radsatz <i>Wheelset</i>	101777	18
25	Zurüstbeutel <i>Bag with accessories</i>	101817	8
26	Bodenplatte für 43006 <i>Main frame for 43006</i>	101838	30
27	Wippe 1 <i>Balance holder 1</i>	101845	3
28	Wippe 2 <i>Balance holder 2</i>	105006	3

